



SonicWALL Backup and Recovery Solutions

BACKUP & RECOVERY

CDP 6080 / CDP 6080B

Getting Started Guide



DYNAMIC SECURITY FOR THE GLOBAL NETWORK™

SonicWALL CDP 6080 / 6080B

Getting Started Guide

This *Getting Started Guide* contains installation procedures and configuration guidelines for deploying a SonicWALL Continuous Data Protection (CDP) appliance into an existing or new network.

The SonicWALL CDP appliance backs up data as changes occur or on a schedule. Data is backed up first to your local SonicWALL CDP appliance, and then optionally to a secure offsite location*. This real-time data protection provides the most current file and system backup possible. By combining the advantages of local disk-based backup (fast recovery) with offsite backup, the SonicWALL CDP appliance provides excellent protection against data loss.

Please read this entire *Getting Started Guide* before setting up your SonicWALL CDP 6080/6080B appliance.



Note: *For more detailed technical documentation, refer to the [SonicWALL CDP Administrator's Guide](#) and the [SonicWALL CDP Agent User's Guide](#) at: <http://www.sonicwall.com/us/Support.html>*

*Offsite backup is offered as a subscription-based service.

Contents

This *Getting Started Guide* contains the following sections:

- 1 *Pre-Configuration Tasks - page 1*
- 2 *Setting Up the SonicWALL CDP Appliance - page 7*
- 3 *Installing and Verifying SonicWALL CDP Agent - page 21*
- 4 *Support and Training Options - page 29*
- 5 *Product Safety and Regulatory Information - page 37*



In this Section:

This section describes the SonicWALL CDP appliance and related components. Review this section before setting up your SonicWALL CDP 6080 appliance.

- [Checking CDP 6080 Package Contents - page 2](#)
- [Overview of the SonicWALL CDP Appliance - page 3](#)
- [Front Bezel Control Features - page 5](#)

Checking CDP 6080 Package Contents

Before setting up your SonicWALL CDP appliance, verify that your package contains the following parts:

- 1 SonicWALL CDP 6080 Appliance
- 2 *Getting Started Guide*
- 3 Ethernet Cable
- 4 (2) Standard Power Cords*
- 5 Front Bezel Keys
- 6 Rack Mounting Kit

Any Items Missing?

If any items are missing from your package, please **contact SonicWALL support**.

A listing of the most current support documents are available online at: <http://www.sonicwall.com/us/Support.html>

*The power cords are intended for use only in the indicated region..

添付の電源コードに関して: 電気安全を確保するために、弊社製品にご使用いただく電源コードは必ず製品同梱の電源コードをご使用ください。この電源コードは他の製品では使用できません。

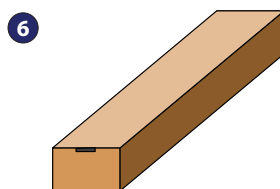
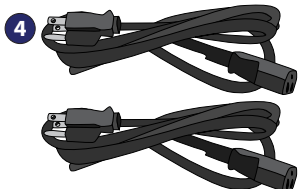
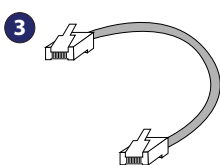
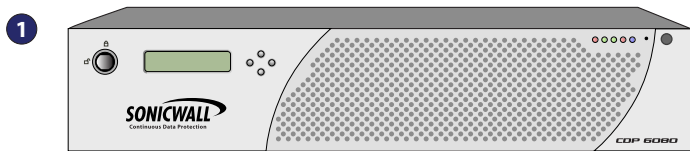

Overview of the SonicWALL CDP Appliance

Front Panel

D-Pad Controls

Provides up, left, right, and down buttons to navigate the LCD menu:

Up/Down: Navigate lists

Left: Cancel changes / return to previous

Right: Accept changes

Power Switch

Allows the SonicWALL CDP appliance to be powered on or off

Reset Button

Reboots the SonicWALL CDP appliance

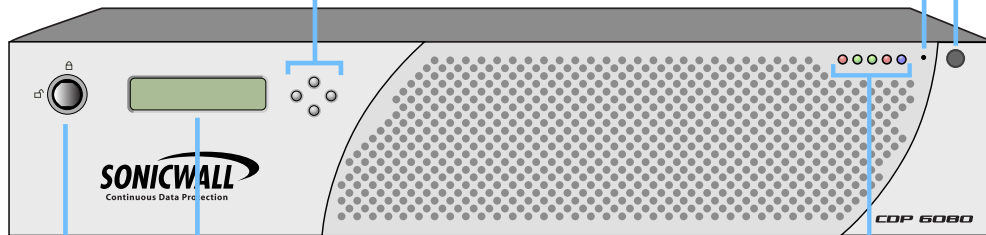

Front Bezel Release

Allows access to drive bays under the front bezel for addition/replacement of hard disks (requires use of included key)

LCD Display

Provides access to basic system information, settings, and features using the D-Pad controls

LED Indicators

Provides the following system status indications:

ALARM: Thermal or other alert condition*

ETH0/ETH1: Ethernet link (solid), activity (blinking)

HDD: Hard disk activity (blinking)

PWR: The appliance is powered (on/off)

*For a full list of alerts, refer to the SonicWALL LED Alerts technote document

- Pressing the reset button for several seconds will result in a reboot of the SonicWALL CDP appliance.
- Do not plug devices into any ports (other than those indicated) unless explicitly instructed to do so by a SonicWALL technical support representative; doing so may void your warranty.

Rear Panel

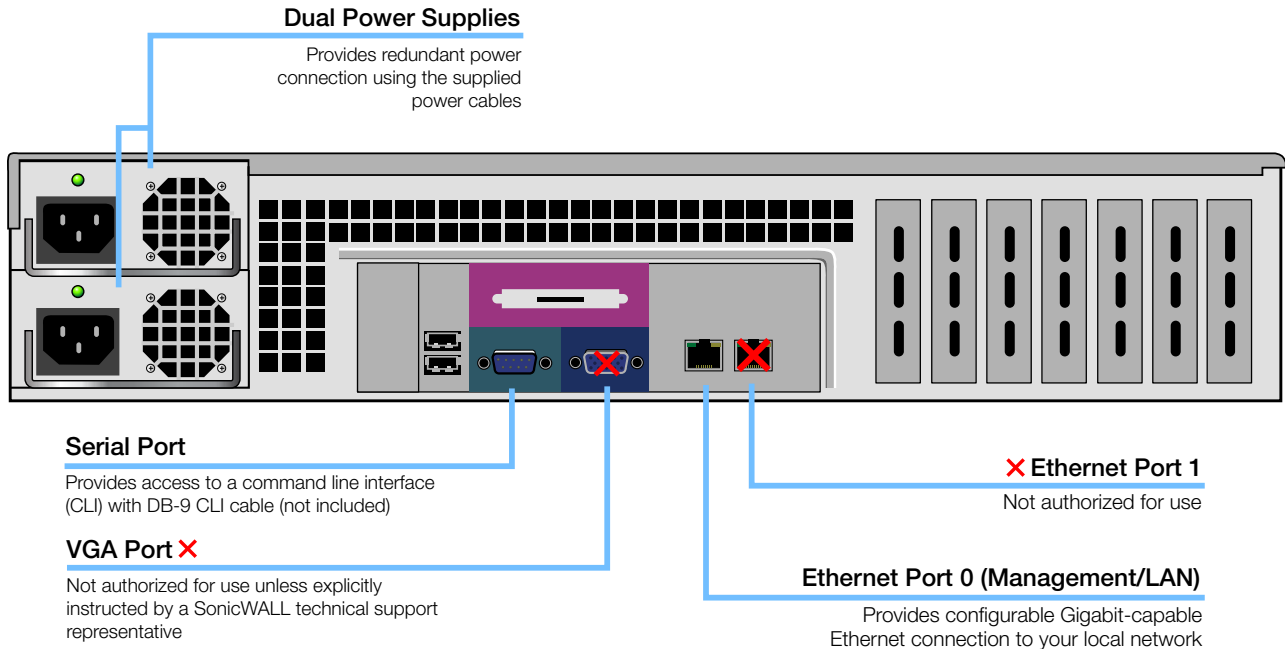

Front Bezel Control Features

The SonicWALL CDP appliance is equipped with a front panel bezel interface that allows an administrator to customize certain aspects of the appliance or simply monitor its status without having to log into it through a separate terminal.

Main Menu

Upon booting, the LCD display initially shows the Main Menu. The menu is made up of two options:

Status >	Contains basic status values including system resources, connections, and port configuration values.
Configure >	Allows configuration of basic LAN port settings. Requires system PIN for access, default: 76642.

Use the **Up** and **Down** buttons to select the menu you wish to enter. Click the **Right** button to enter it.

Status

The Status menu allows you to view specific aspects of the appliance. Once selected, the LCD displays the Status List. This list is navigated using the **Up** and **Down** buttons. Status options include:

- Appliance name
- Software version
- Date
- Time
- Uptime
- Management URL
- Interface eth0 IP (default LAN)
- Interface eth0 subnet

Configure

The Configure Menu allows you to configure specific aspects of the appliance. Once selected, the LCD displays a PIN request.



Note: *The Default PIN is **76642**. This number spells SONIC on a phone keypad. The PIN number can be changed from the **System > Administration** page.*

All numbers are inputted using the 4 buttons. Select the individual digit field using the **Left** and **Right** button and select the desired number using the **Up** and **Down** button. Digits increase incrementally from 0 to 9. Press the **Right** button to confirm your PIN and enter the Configuration Menu.

The appliance allows the user to navigate in and out of the Configuration Menu without having to re-enter the PIN. However, once the appliance enters Screen-Saver Mode, whether from the 6-second time out or from pressing the **Left** button from the Main Menu, the PIN number must be re-entered again to access the Configuration Menu.

After entering a new value for a setting in the configuration menu, you are asked if you want to commit changes. Using the 4-way D-pad, press the **Right** button for yes or the **Left** button for no.



Commit Changes?
<-No Yes->

If you choose yes, the screen notifies you that the settings are updated.



Settings updated

In this Section:

This section contains the following subsections:

- *What You Need to Begin - page 8*
- *Registering Your SonicWALL CDP Appliance on MySonicWALL - page 8*
- *Determining Network Information - page 12*
- *Powering On and Connecting to the Appliance - page 13*
- *Configuring Appliance Settings - page 15*
- *Connecting the SonicWALL CDP Appliance to Your Network - page 18*
- *Configuring Mail Settings - page 19*
- *Activating Your SonicWALL CDP Appliance - page 20*

What You Need to Begin

A computer that meets or exceeds the following requirements:

- Pentium III 450 MHZ processor
- 256 MB of RAM
- 40 MB of free disk space
- A broadband Internet connection (DSL, cable, T1, or other)
- A 10/100 Base-T Ethernet hub / router
- Microsoft Windows 7, Vista, XP, Server 2008, Server 2003*

*For the latest list of supported Windows operating systems and service packs, refer to the *SonicWALL CDP Release Notes* and the following webpage:

<http://www.sonicwall.com/us/products/backup_and_recovery.html>

Registering Your SonicWALL CDP Appliance on MySonicWALL

The SonicWALL CDP appliance must be registered on MySonicWALL before first use. Perform the following steps to register your SonicWALL CDP appliance:

1. Point your Web browser to www.mysonicwall.com.
The MySonicWALL login page is displayed.

SONICWALL

English | Français(French) | Deutsch(German) | Italiano(Italian) | 日本語(Japanese) | Español(Spanish) | 中文(Chinese)

Login to MySonicWALL

Username/Email: [Forgot?](#)

Password: [Forgot?](#)

Home

Not a registered user? [Register Now](#)

SonicWALL, Inc. | © 2012 [Privacy Policy](#) | [Conditions for use](#) | [Feedback](#)

- Enter your MySonicWALL account credentials in the **Username** and **Password** fields and then click the **Submit** button.



Note: *You need a MySonicWALL account to register the SonicWALL CDP 6080. You can create one by clicking the **Register Now** link.*

- On the MySonicWALL page, click **My Products** in the navigation bar. Then, select **Register Product**.



- Complete the fields as described in the table below:

Field	Description
Serial Number	Enter the serial number, found on the bottom of your SonicWALL CDP appliance.
Friendly Name	Enter a descriptive name for your SonicWALL CDP appliance.

Product Group	Select a product group from the drop-down menu. This product group is a logical collection of SonicWALL products that are managed by a user group, defined on MySonicWALL.
Authentication Code	Enter your authentication code, found on the bottom of your SonicWALL CDP appliance (just below the serial number).

Register Product

Add New Product Client Distribution Group

Fields marked by (*) are mandatory.

General Info

Serial Number: ? *

Friendly Name:

Product Group: ▼

Authentication Code: ? -

5. Click the **Submit** button.
The message “Please select an offsite backup location” displays:

Register Product

Add New Product Client Distribution Group

Fields marked by (*) are mandatory.

General Info

Serial Number: *

Friendly Name:

Product Group:

Authentication Code: -

Please select an offsite backup location.

Location:

6. In the **Location** drop-down menu, select an offsite data backup location, either **NORTH AMERICA - WEST** or **Europe**.

Please select an offsite backup location.

Location:

- Select One
- NORTH AMERICA - WEST
- Europe
- Select One



Alert: *If you change the offsite data backup location, the data that was saved in the previous location is lost.*

7. Click the **Submit** button.
The Service Management page is displayed.

Service Management

CDP Product Registered Successfully.

[To get the latest applicable firmware/software, please click here.](#)

Techpubs CDP

Serial Number:	0017C70A1706	Node Support:	Unlimited
Registration Code:	8MFLXXX3	Platform:	CDP
Authentication Code:	XXXX-XXXX	Product:	SonicWALL CDP
Trusted:	No		
Offsite Backup Location:	NORTH AMERICA - WEST		
Registered On:	01 Feb 2012		

Add licenses manually to your product: [View License keyset](#)



Note: *You will need the **Registration Code** during initial configuration of your SonicWALL CDP.*

Activating Offsite Data Backup Service

The SonicWALL CDP Offsite Data Backup Service is an optional offsite backup and recovery solution. Perform the following steps to activate your Offsite Data Backup Service:

1. On the Service Management page in MySonicWALL, scroll down to **Applicable Services**. If you do not have an Offsite Data Backup Service activation key, click the Buy icon or contact your SonicWALL vendor.
If you have a license key, click the Key icon.

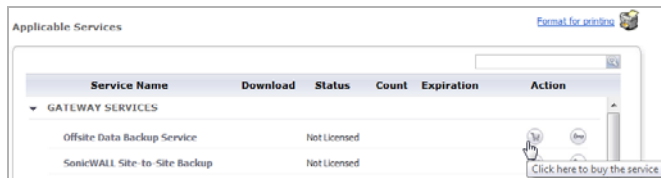

2. Type your key into the **Activation Key** field, select the **I have read and agreed to all of the terms and conditions mentioned above** checkbox, and then click **Submit**.

Activate Service: Offsite Data Backup Service

Please enter the Activation Key(s).
Multiple activations can be performed by adding keys for the same service separated by a comma,space or enter key.

Activation Key(s):

Terms and Conditions

CONTINUOUS DATA PROTECTION OFFSITE SERVICE AGREEMENT THE FOLLOWING ARE THE TERMS AND

The activation status displays with the expiration date and offsite capacity.

Service Name	Download	Status	Count	Expiration
GATEWAY SERVICES				
Offsite Data Backup Service		Licensed	5	Jan 31 2013

Activation Status:	Enabled
Expiration Date:	Jan 31 2013
Offsite Capacity (GB):	5

3. To activate the **SonicWALL Site-to-Site Backup** service, click the Buy or Key icon.
4. To enter an existing license key, use the same method as described above for the Offsite Data Backup Service.



Note: Bare Metal Recovery and other services can also be activated on the Service Management page. For information about using Bare Metal Recovery, refer to the SonicWALL Bare Metal Recovery Administrator's Guide, available on MySonicWALL or at: <http://www.sonicwall.com/us/Support.html>

Determining Network Information

Before continuing, determine the following network configuration information and record it for your reference:

Networking Information

CDP IP Address: _____	Select an available static IP address for your SonicWALL CDP appliance that is within the range of your local subnet.
CDP Subnet Mask: _____	Enter the subnet mask for the local subnet where you are installing your SonicWALL CDP appliance.
Gateway IP Address: _____	Record the IP address of your network's gateway device (such as your perimeter firewall/router).
DNS Server 1: _____ DNS Server 2 (optional): _____	Record your DNS Server information.

General Information

Server Name: _____	Select a friendly name for your SonicWALL CDP appliance (maximum 32 characters).
Password: _____	Select a password for your SonicWALL CDP appliance (default is <i>password</i>).
Serial Number: _____	Record the serial number found on the bottom of your SonicWALL CDP appliance.
Authentication Code: _____	Record the authentication code found on the bottom of your SonicWALL CDP appliance.
Registration Code: _____	Record the registration code that is generated in mysonicwall.com. See Registering Your SonicWALL CDP Appliance on MySonicWALL - page 8 .

Powering On and Connecting to the Appliance

After registering your SonicWALL CDP appliance on MySonicWALL, you are ready to turn on the appliance and connect a computer to it for initial configuration.

1. Place the SonicWALL CDP appliance and your management computer next to each other for the initialization process.
2. Set the LAN IP address of your management computer to a static IP address on the 192.168.168.0/24 subnet, such as **192.168.168.50**. For help with setting a static IP address on your computer, refer to [Configuring a Static IP Address on Windows - page 14](#).
3. Using an Ethernet cable, connect the LAN port of computer to the LAN port on the back of your SonicWALL CDP appliance.

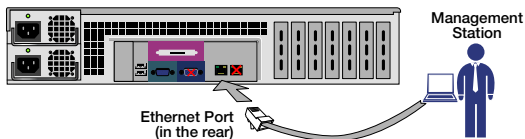

4. Securely attach each provided power adaptor to a provided power cord.
5. Connect the power adaptors to the back of the appliance, and insert the plug ends into grounded 110/120V outlets. For redundancy, plug the power adaptors into outlets on different circuits.

6. If the appliance does not power up immediately, press the power switch on the front to turn it on.
7. Open a Web browser on the computer and point it to: **http://192.168.168.169** (the default IP address of the SonicWALL CDP appliance). The SonicWALL CDP login screen displays.



Note: *One or more security warnings may display while connecting to the SonicWALL CDP Web management interface. Continue to the website, and accept the certificate if required, to login to the SonicWALL CDP appliance.*

8. Enter “admin” in the **Name** field and “password” in the **Password** field, select your language from the **Language** drop-down menu, and click the **Login** button.



Configuring a Static IP Address on Windows

Complete the following steps to configure your management computer with a static IP address:

Windows 7

1. Open a **My Computer** window.
2. Type **Network Connections** into the location bar at the top of the window and press **Enter**.
The window changes to the Control Panel > All Control Panel Items > Network Connections folder.
3. In the Network Connections window, double-click **Local Area Connection**.
4. If the Local Area Connection Status window opens, click the **Properties** button.
5. In the Local Area Connection Properties window, select **Internet Protocol Version 4 (TCP/IPv4)**, and then click the **Properties** button.
6. Select **Use the following IP address** and type an IP address on the 192.168.168.0/24 subnet, such as **192.168.168.50**, in the **IP address** field.
7. Type **255.255.255.0** in the **Subnet Mask** field.
8. Click **OK** in the Properties window.
9. Click **Close** in the Local Area Connection Properties window for the settings to take effect.

Windows XP

1. On the Windows **Start** menu, highlight **Connect To** and then select **Show All Connections** to open the Network Connections window.
If **Connect To** is not available, directly select **Network Connections**, or select **Control Panel** and then double-click **Network Connections** in the Control Panel window.
2. In the Network Connections window, double-click **Local Area Connection**.
3. In the Local Area Connection Status window, click the **Properties** button.
4. In the Local Area Connection Properties window, select **Internet Protocol (TCP/IP)**, and then click the **Properties** button.
5. Select **Use the following IP address** and type an IP address on the 192.168.168.0/24 subnet, such as **192.168.168.50**, in the **IP address** field.
6. Type **255.255.255.0** in the **Subnet Mask** field.
7. Click **OK** in the Properties window.
8. Click **Close** or **OK** in the Local Area Connection Properties window for the settings to take effect.

Configuring Appliance Settings

After registering your SonicWALL CDP on MySonicWALL and connecting a management computer to it, you are ready to configure the appliance for use on your network.

Changing the Administrator Password

1. On the System > Settings page, click the **Password** tab.
2. Type the desired password into the **Password** field, and again into the **Verify Password** field, then click **Apply**. You are logged out of the SonicWALL CDP appliance.
3. In the Logged Out screen, click the **Login Again** button and then log in as “admin” using your new password.

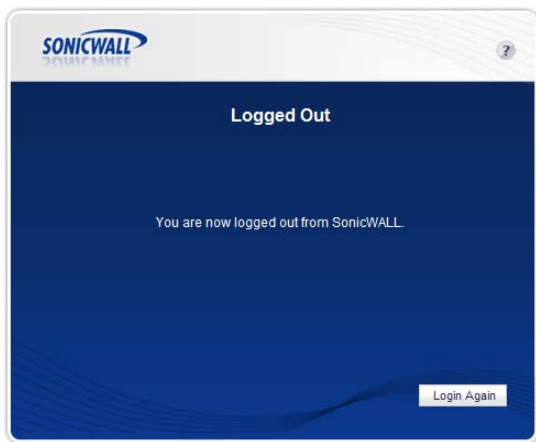

Configuring Local Time Zone Settings

1. On the System > Settings page, click the **Time** tab.
2. Complete the fields as described in the table below, then click **Apply**.

Field	Description
Time (hh:mm:ss)	Select the time in 24-hour format by clicking the up or down arrows next to each field (hours, minutes, seconds).
Date	Select the date (month, day, year) from the pop-up calendar.
Time Zone	Select your local time zone from the drop-down list.
Set Time Automatically using NTP	Select this checkbox to allow the time to be set automatically using NTP. Configure NTP servers on the NTP tab.

Configuring the Appliance Host Name and Domain

To allow access to your SonicWALL CDP appliance by fully qualified domain name (FQDN), you must configure a unique host name and set the domain.

1. In the Web management interface, click **Network** in the navigation pane, and then click **Settings**.
2. On the **Summary** tab, type the host name for the CDP appliance into the **Host Name** field.
3. Type the domain used by the appliance into the **Host Domain** field.
4. Type a descriptive name for the appliance into the **Friendly Name** field. This name is displayed in the Available Appliances list when initializing the SonicWALL CDP Agent on a client machine.
5. Click the **Apply** button.

Configuring the Domain Name Server Address

You must configure the correct DNS address settings in order to register and use your SonicWALL CDP appliance. The DNS server must be able to resolve external Internet names.

For your records, enter the DNS server IP address below.

DNS Server IP address:

See [Determining Network Information - page 12](#)

_____._____._____._____

1. In the Web management interface, click **Network** in the navigation pane, and then click **Settings**.
2. On the **Name Server** tab, click the Configure icon for the DNS IP address.
3. In the **Server** field, type in the IP address of the DNS server used in your local network. You can look at the DNS settings on your gateway appliance to determine this.



The screenshot shows a dialog box titled "Edit Name Server" with a close button (X) in the top right corner. Inside the dialog, there is a text input field labeled "Server:" containing the IP address "10.50.128.52". Below the input field are two buttons: "OK" and "Cancel".

4. Click **OK**.

Configuring a Static IP Address for the Appliance

This procedure describes how to configure your SonicWALL CDP appliance with a static IP address. After changing the IP address of your appliance, you must point your browser to the new IP address to access the Web management interface.

For your records, enter the chosen IP address for your SonicWALL CDP appliance in the space provided below.

CDP IP address:

See [Determining Network Information - page 12](#)

_____._____._____._____

1. In the Web management interface, click **Network** in the navigation pane, and then click **Settings**.
2. On the **Interface** tab, click the Configure icon for the **eth0** interface.

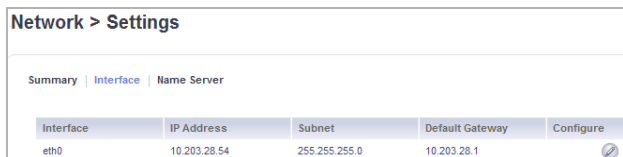

Interface	IP Address	Subnet	Default Gateway	Configure
eth0	10.203.28.54	255.255.255.0	10.203.28.1	

3. In the **IP Address** field, enter an unused static IP address that is within the range of your local subnet. For example, if the LAN IP address of your gateway firewall is 10.215.10.1 and the subnet mask is 255.255.255.0, you could set the static IP address on your SonicWALL CDP appliance to 10.215.10.61.

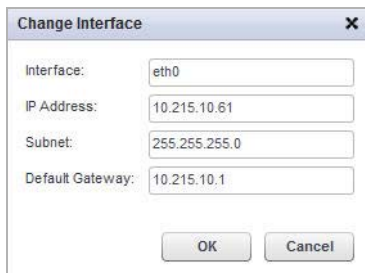

Change Interface

Interface:

IP Address:

Subnet:

Default Gateway:

4. In the **Subnet** field, enter your subnet mask.

5. In the **Default Gateway** field, enter the IP address of the default gateway (usually a firewall) for your local network.
6. Click **OK**. A Processing indicator is displayed, but your session is already disconnected and you do not need to wait.



Note: *After applying the IP address change, your current Web management interface session is disconnected. You must point your browser to the new IP address to access the Web management interface again.*

7. Disconnect the Ethernet cable from your computer and from the SonicWALL CDP appliance.
8. Reset your computer to use the **Obtain an IP address automatically** option, if using a DHCP server, or reset it to the original static IP address for your LAN. See [Configuring a Static IP Address on Windows - page 14](#).
9. If using a wired connection, reconnect your computer to an available port on a network device on your local network.

Continue to the next section to connect the SonicWALL CDP appliance to your local area network.

Connecting the SonicWALL CDP Appliance to Your Network

Your SonicWALL CDP appliance is designed to operate in most network deployments with minimal configuration.

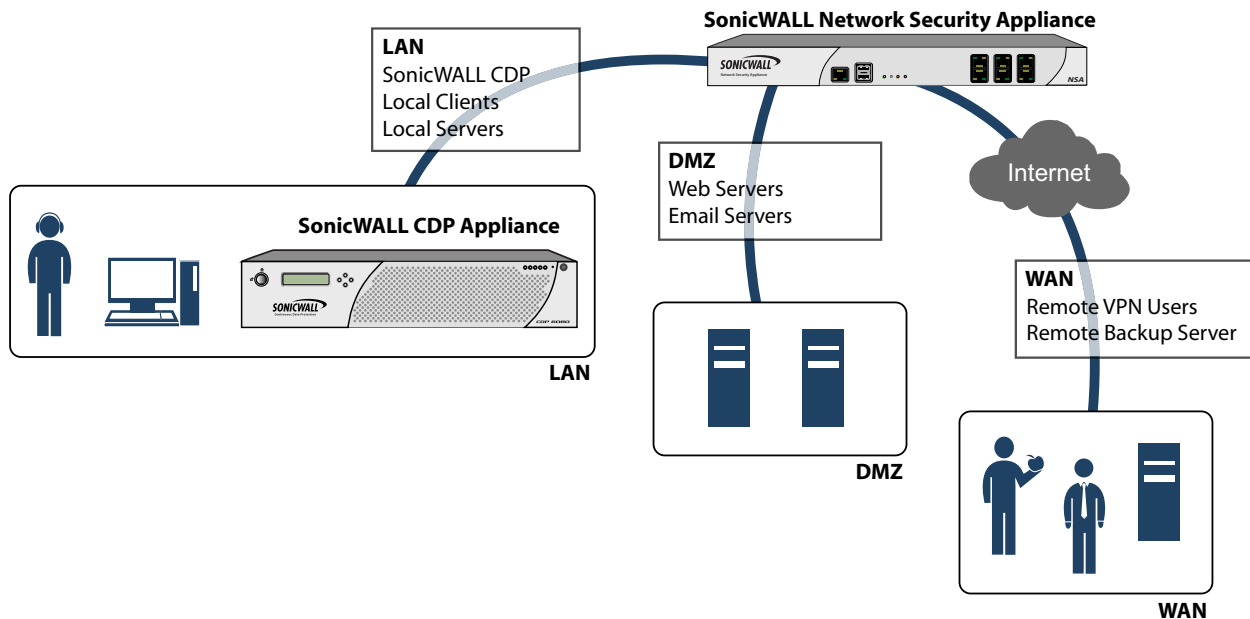

Perform the following steps to physically connect your SonicWALL CDP appliance to your network:

1. Plug one end of the provided Ethernet cable into the LAN port on the back of your SonicWALL CDP appliance.
2. Plug the other end of the cable into an open port on your network hub or switch.

Configuring Mail Settings

Mail settings are required for the administrator to receive email alerts. The **Alerts** tab already contains default alert settings.



Note: *You must complete the network configuration of the appliance and physically connect it to your local area network to allow mail settings to work properly.*

1. Log in to a management computer that is connected to a network device on your local network.
2. Point your browser to the static IP address of the SonicWALL CDP appliance. The CDP login screen displays.
3. Log in as **admin**, using the configured administrator password.
4. On the System > Settings page, click the **Mail** tab.

5. Complete the fields as described in the table below:

Field	Description
Server	Type in the name or IP address of the mail server; for example, mail.company.com.
Recipient Email Address	Type in the email address of the administrator for the SonicWALL CDP appliance.
From Email Address	Type in the email address to use as the sender when alert emails are sent to the administrator; for example, appliance_name@company.com.
From Email Domain	Type in the domain used by the sender; for example, localdomain or a regional domain.
Username	Type in a user name for the From Email Address , if required by your mail server.
Password	Type in a password for the From Email Address , if required by your mail server.
Verify Password	Re-enter the password.

6. Click **Apply**.
7. Click **Send Test Email** to send a test email to the configured Recipient Email Address.

Activating Your SonicWALL CDP Appliance

Perform the following steps to activate your SonicWALL CDP appliance. You will need the product registration code that you obtained in [Registering Your SonicWALL CDP Appliance on MySonicWALL - page 8](#) to complete this section.



Alert: *If the appliance does not have Internet connectivity, you will need to use the Manual Keyset to activate SonicWALL CDP. The Manual Keyset is available on MySonicWALL.*

For information about upgrading the firmware after activating your appliance, see the *Upgrading Appliance Firmware* section in the *SonicWALL CDP Administrator's Guide*, and check the release notes for special instructions.

1. On your management computer, point your browser to the SonicWALL CDP appliance IP address and log in to the Web management interface.
Type “admin” for the username, and type in the current password for the admin account.
2. Click the **Register** button in the top right corner of the Web management interface.



The **System > Registration/Licenses** page is displayed.

3. Type the product registration code from MySonicWALL into the **Registration Code** field.

System > Registration/Licenses

Registration | Licenses | Manual Keyset

Register Status: Not Registered

Registration Code:

Register

4. Click the **Register** button.

The Processing indicator appears for a few seconds, and then the Registration Code field appears as **Registered** when finished.

System > Registration/Licenses

Registration | Licenses | Manual Keyset

Register Status: Registered

Register

You have successfully completed registration and activated your SonicWALL CDP appliance. Your SonicWALL CDP 6080 is now fully operational. Continue with [Installing and Verifying SonicWALL CDP Agent - page 21](#).

In this Section:

This section provides instructions for installing the SonicWALL CDP Agent software and testing backup functionality with your SonicWALL CDP appliance.

- [SonicWALL CDP User Interfaces - page 22](#)
- [Downloading and Installing SonicWALL CDP Agent Software - page 22](#)
- [Verifying SonicWALL CDP Operation - page 26](#)
- [Troubleshooting SonicWALL CDP Agent Operation - page 28](#)

SonicWALL CDP User Interfaces

SonicWALL provides the following user interfaces for managing the features and functionality of the SonicWALL CDP:

SonicWALL CDP Web Management Interface—Accessed through a browser, this Web-based interface runs on the appliance and is used by the SonicWALL CDP administrator to configure local and global policies, obtain logs and reports, set email notifications and other administrative settings, configure network settings, access system diagnostics, and manage agent machines.

SonicWALL CDP Agent User Interface—This application runs on individual user workstations, allowing users to connect to the SonicWALL CDP appliance, create backup tasks and schedules, and restore file sets and application data. Administrators can use the Agent User Interface to access, edit, and restore backup data on SonicWALL CDP appliances for all agent machines.

SonicWALL CDP Local Archive Manager—This application allows you to copy data from a SonicWALL CDP appliance onto a USB drive, and to restore the data from the USB drive to an individual computer or server. The data can be encrypted on the USB drive, and you can configure local archiving tasks that periodically copy data from the appliance to a USB drive.

Downloading and Installing SonicWALL CDP Agent Software

Perform the following procedures to install the SonicWALL CDP Agent and Local Archive Manager software on each agent computer that requires access to the SonicWALL CDP appliance for data backup.

Downloading the Latest SonicWALL CDP Agent Software

1. Open a Web browser on the agent computer.
2. Enter <<https://www.mysonicwall.com>> in the Location or Address bar. The MySonicWALL login page displays.
3. Log in to MySonicWALL, and click **Download Center** in the left navigation pane.
4. Select the CDP Firmware/Software option matching your appliance model from the **Software Type** drop-down menu.

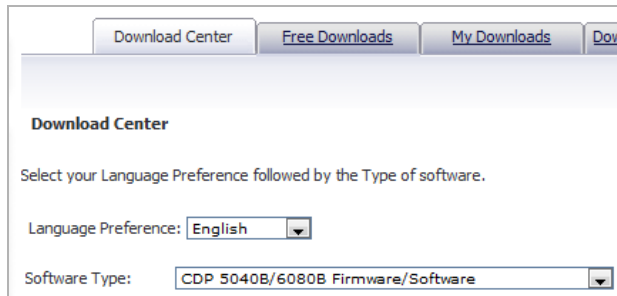

5. Locate the CDP Agent Software link for your agent machine (Windows/Mac/Linux) under **Description** in the Available Software section of the page.
6. Depending on your browser, either click or right-click on the desired Agent software link, and follow the prompts to save the installer to a location on your computer.

Installing the SonicWALL CDP Agent Software

1. Navigate to the folder where you downloaded the installer.
2. Double-click the CDPSetup.exe file to begin the installation process.
If you are running Windows or using a third-party firewall, you may receive a warning during installation of the SonicWALL CDP Agent software. For more information on configuring your firewall to work with the SonicWALL CDP appliance, refer to the *SonicWALL CDP Agent User's Guide*.
3. Click **Next** in the Welcome screen.

4. In the End-User License Agreement screen, select the **I accept the terms in the license agreement** checkbox, and click **Next** to continue.

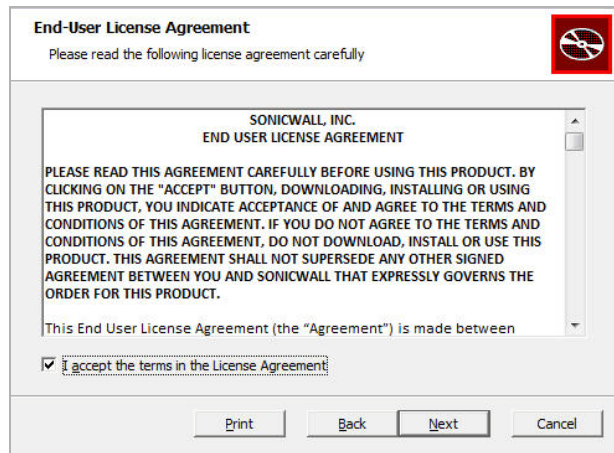

5. In the Choose Setup Type screen, select either **Typical**, **Custom** or **Complete**, and then click **Next**.

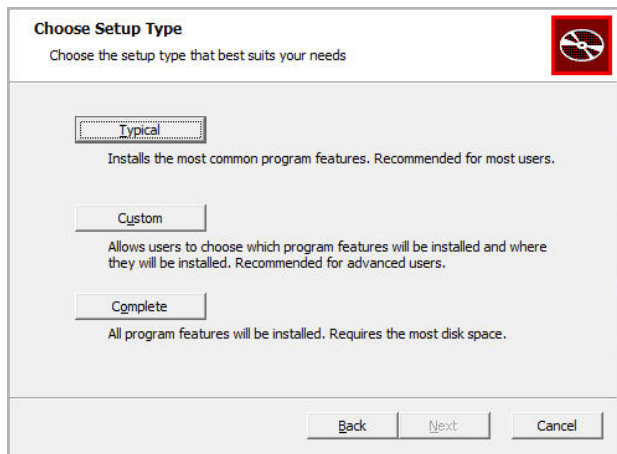

Typical installation installs the most common program features, including the Agent User Interface and Agent Service. A Typical installation uses less disk space than a Complete installation. The Local Archive Manager is not installed with a Typical installation.

Complete installation will install all the program features. To include the Local Archive Manager in the installation, select **Complete**.

Custom installation allows you to select which program features you want installed. This installation option is recommended for advanced users.

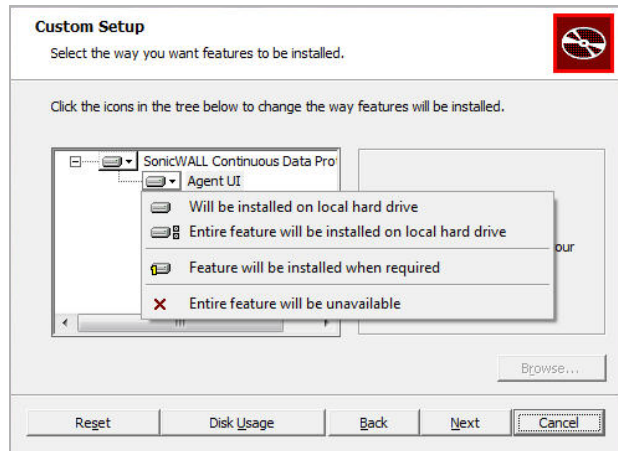

- The installer displays a screen asking if you want to install the **Adobe AIR** application, which is required for proper operation of the Agent User Interface. Click **Install** to continue the Agent software installation.
- In the Ready to Install SonicWALL CDP screen, click **Install** to begin the actual installation.

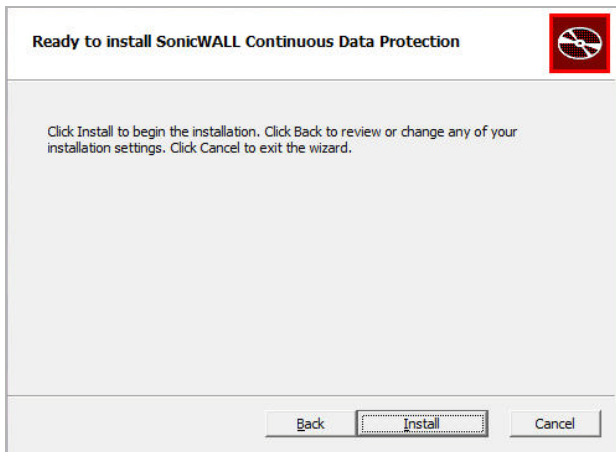

- Once the software installation is complete, click **Finish**.

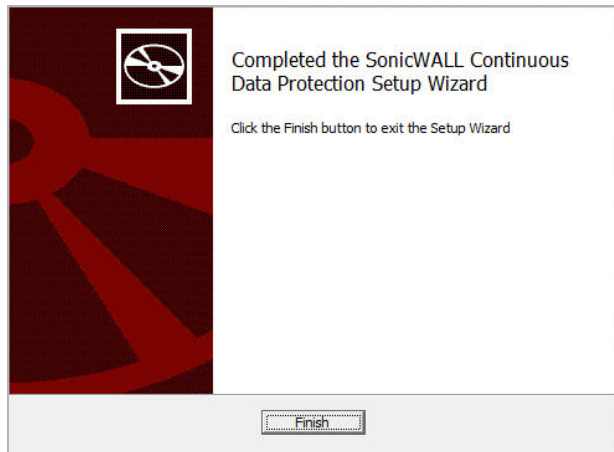

The installer places shortcuts on the computer desktop for the SonicWALL CDP Agent UI and SonicWALL CDP Local Archive Manager (if installed).

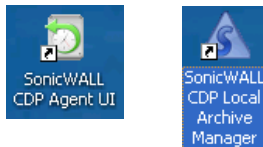

Verifying SonicWALL CDP Operation

To verify that your SonicWALL CDP appliance can successfully back up data from an agent computer, perform the following steps:

1. Launch the SonicWALL CDP Agent User Interface by double-clicking the desktop shortcut or from the Windows Start menu:
Programs > SonicWALL > SonicWALL Continuous Data Protection > SonicWALL CDP Agent UI.
If you are running Windows or using a third-party firewall, you may receive a warning asking to accept the certificate when you launch the SonicWALL CDP software. Accept the certificate to continue.
2. In the CDP Agent User Interface, click the **Change Appliance** icon at the bottom of the left pane to show available appliances.



3. Select the recently registered SonicWALL CDP appliance and click the **Connect to Appliance** icon.



4. Click the **Policies** tab.
5. Double-click **Files and Folders: Default CDP Files and Folders**, to edit it.
The Files and Folders window opens.

6. In the left pane, under **Computer**, select a folder that has some files you can back up for this test.

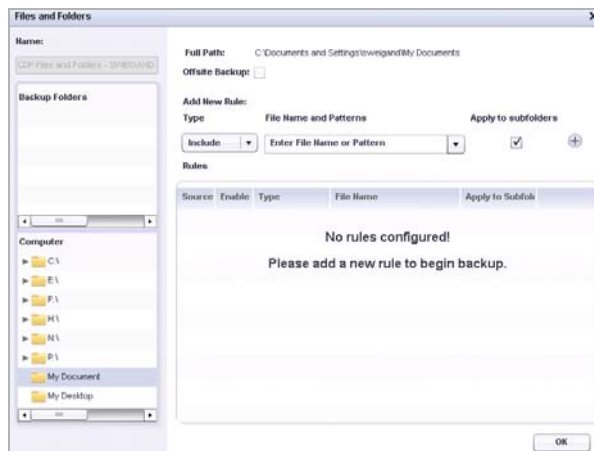

7. Under **Add New Rule**, select **All Files** or a specific file type from the **File Name and Patterns** drop-down list for backup.
 8. Click the Plus button to add the rule.
- A small circular button with a plus sign (+) inside.
9. Click **OK**.
Backups begin immediately when using CDP Method.

- Click the **My Backups** tab to view specific folders and check backup status.

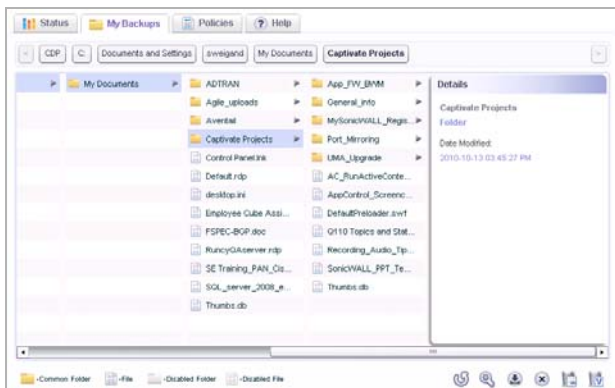

- Click the **Status** tab to see data being backed up and view the quota used.



Note: For more information on configuring your SonicWALL CDP appliance, refer to the [SonicWALL CDP Administrator's Guide](#) and the [SonicWALL CDP Agent User's Guide](#) at:
<http://www.sonicwall.com/us/Support.html>

Congratulations! You have successfully set up and tested your SonicWALL CDP appliance operation.

To enable additional computers to back up data to the SonicWALL CDP 6080 appliance, simply install the SonicWALL CDP Agent software on each computer.

Troubleshooting SonicWALL CDP Agent Operation

If your SonicWALL CDP Agent application does not start, verify the following:

1. The software must be installed by a user with administrative rights.
2. The operating system must be upgraded to the latest released service pack.
3. If you have a personal firewall, add exceptions for the following:
 - CDPAgentservice.exe
 - Lasso.Client.exe
 - CDPAutoUpdate.exe
4. If you are running Microsoft Windows XP SP2 or Windows Server 2003, verify that Data Execution Prevention (DEP) is configured to allow SonicWALL CDP:
 - Under Windows Services, stop the CDPAgentService.exe service.
 - Right-click **My Computer** and select **Properties**, then select the **Advanced** tab.
 - Under **Performance**, click **Settings**.
 - Select the **Data Execution Prevention** tab.
 - If DEP is enabled for all programs and services, then add CDPAgentService.exe, CDPAutoUpdate.exe, and Lasso.Client.exe to the list.
 - Click **Apply**.
 - Start the Agent Service again.
5. Verify that there is no other content filtering or personal firewall software running.

In this Section:

This section provides overviews of customer support and training options for the SonicWALL CDP 6080.

- [*Customer Support - page 30*](#)
- [*SonicWALL Live Product Demos - page 30*](#)
- [*Knowledge Portal - page 31*](#)
- [*SonicWALL User Forums - page 32*](#)
- [*Training - page 33*](#)
- [*Related Documentation - page 34*](#)
- [*SonicWALL Secure Wireless Network Integrated Solutions Guide - page 35*](#)

Customer Support

SonicWALL offers Web-based and telephone support to customers who have a valid warranty or who have purchased a Support Contract. SonicWALL also offers a full range of consulting services to meet your needs, from our innovative implementation services to traditional statement of work-based services.

For further information, visit:

<<http://www.sonicwall.com/us/support/contact.html>>

The screenshot shows the SonicWALL website's support page. The navigation bar includes 'Products', 'Solutions', 'How to Buy', 'Support', 'Sign In', and 'Register'. The main content area is titled 'Contact SonicWALL Support' and provides an overview of support services, including chat, email, and web-based support. A 'Chat Support for Firewall Products' section specifies availability for North America. An 'Email Support' section lists steps for requesting support, such as sending an email to support@sonicwall.com and including product details.

SonicWALL Live Product Demos

The SonicWALL Live Demo site provides free test drives of SonicWALL security products and services through interactive live product installations:

- SonicOS Deep Packet Inspection Platform
- Continuous Data Protection
- SSL VPN Secure Remote Access
- Content Filtering
- Secure Wireless Solutions
- Email Security
- SonicWALL GMS and ViewPoint

For further information, visit:

<<http://livedemo.sonicwall.com/>>

The screenshot shows the SonicWALL Live Demo Site. The header includes the SonicWALL logo and 'LIVE DEMOSITE'. A welcome message states that the site provides a portal for real product demonstrations. A 'Launch The Live Demo Site' button is visible. A 'Live Demo Network Status' box shows 'Congrats flamesh! http://t.co/7DcQevd0 SL1000.00'. Below, six product categories are listed with icons and descriptions: UTM/Application Control/Firewall/VPN, Backup and Recovery, Secure Remote Access, Anti Spam and Email Security, Management and Reporting, and Technology Partners.

Knowledge Portal

The Knowledge Portal allows users to search for SonicWALL documents based on the following types of search tools:

- Browse
- Search for keywords
- Full-text search

For further information, navigate to the **Support > Knowledge Portal** page at:

<http://www.mysonicwall.com/>

The screenshot shows the SonicWALL Knowledge Portal search interface. At the top left is the SonicWALL logo. To the right is a 'Home' link. Below the logo are navigation tabs: 'Q&A Search', 'Ask A Question', 'My Profile', and 'My Alerts'. The main search area is divided into three sections: 'Search Using Text', 'Refine search by product', and 'Sort Search Results'. The 'Search Using Text' section has a search input field and radio button options for search criteria: 'Any words match', 'All words match' (selected), 'Exact phrase matches', and 'Match KBID'. There is also a checkbox for 'Search Archived Items 2'. The 'Refine search by product' section has three dropdown menus: 'Select your product', 'Select your topic within product', and 'Select your sub-topic', followed by a 'Go' button and a checkbox for 'Do not search subcategories'. The 'Sort Search Results' section has a dropdown menu set to 'Relevance'. Below the search area are links for 'Search Tips', 'What's New', and 'What's Hot'. A message encourages users to click the 'Rate' button for feedback. A 'Create Case' button is also present. At the bottom, a section titled 'Most Relevant Info For All Categories' shows a list of four articles, each with a 'Priority Item' label. The list includes: 'Most popular SonicWALL UTM Firewall Configurations', 'UTM: Do you need help with Opening Ports, NAT Policies or Firewall Access rules?', 'UTM: Are you looking for "ISP / WAN connectivity" related articles?', and 'UTM: Troubleshooting ISP / WAN or Internet connectivity Issues'.

SonicWALL User Forums

The SonicWALL User Forums allow users to communicate and discuss a variety of security and appliance subject matters. The forums include a variety of topics among the following categories:

- Firewall topics
- SSL VPN topics
- Mobile Connect topics
- Continuous Data Protection topics
- Email Security topics
- Scrutinizer topics
- WAN Acceleration topics
- Content Security Manager topics
- GMS, Analyzer, and ViewPoint topics
- Network Anti-Virus topics
- Security Services and Content Filtering topics
- SonicPoint and Wireless topics
- VPN Client topics
- VPN site-to-site and interoperability topics
- Beta Forums

For further information, log in to the SonicWALL Forums website using your MySonicWALL account credentials:
<<https://forum.sonicwall.com/>>

The screenshot shows the SonicWALL User Forums website. At the top, there is a navigation bar with links for User CP, FAQ, Calendar, New Posts, Search, Quick Links, KnowledgePortal, and Log Out. A welcome message for 'techpubs' is displayed, indicating the user's last visit and unread private messages. The main content area is a forum listing table with columns for Forum, Last Post, Threads, and Posts. The forums are organized into sections: Firewalls, SonicWALL SSL-VPN, SonicWALL Mobile Connect, Aventail SSL VPN, SonicWALL CDP, SonicWALL Email Security, Sonicwall Scrutinizer, WAN Acceleration (WXA), SonicWALL CSM Devices, and a BETA FORUMS section. The BETA FORUMS section includes Email Security and SonicWALL CDP.

Forum	Last Post	Threads	Posts
Firewalls Firewall related topics			
Analyzer / GMS / Viewpoint Analyzer, GMS and Viewpoint related topics	SonicWall GMS 6.0 CLI guide by SGT2RHEP02-06-2012 01:07 AM	1,431	5,049
SonicWALL SSL-VPN SSL-VPN Topics			
SonicWALL Mobile Connect			
Aventail SSL VPN For discussions about the Aventail E-Class SSL VPN Appliance Series			
SonicWALL CDP Continuous Data Protection Topics			
Bare Metal	Are Bare Metal Restore files... by holmans 01-16-2012 02:07 PM	51	147
Appliance	Schedules again by duodec Today 07:30 AM	174	667
Software Tools	Revision issues by sxeel@koppesbouwkunda.nl02-06-2012 12:23 AM	103	428
Offsite Backup Service	Status by ticketreturn01-31-2012 08:25 AM	40	125
Misc	SNMP Monitoring of Multite... by carson1 01-16-2012 05:43 AM	253	821
SonicWALL Email Security SonicWALL Email Security related topics			
Sonicwall Scrutinizer Forum for discussing the Sonicwall Scrutinizer product released in October 2011.			
WAN Acceleration (WXA) WAN Acceleration (with SonicDS 5.8.1.0 or later)			
SonicWALL CSM Devices Content Security Manager topics			
** BETA FORUMS **			
Email Security			
SonicWALL CDP			

Training

SonicWALL offers an extensive sales and technical training curriculum for Network Administrators, Security Experts and SonicWALL Medallion Partners who want to enhance their knowledge and maximize their investment in SonicWALL Products and Security Applications. SonicWALL Training provides the following resources for its customers:

- E-Training
- Instructor-Led Training
- Custom Training
- Technical Certification
- Authorized Training Partners

For further information, visit:

<<http://www.sonicwall.com/us/support/training.html>>

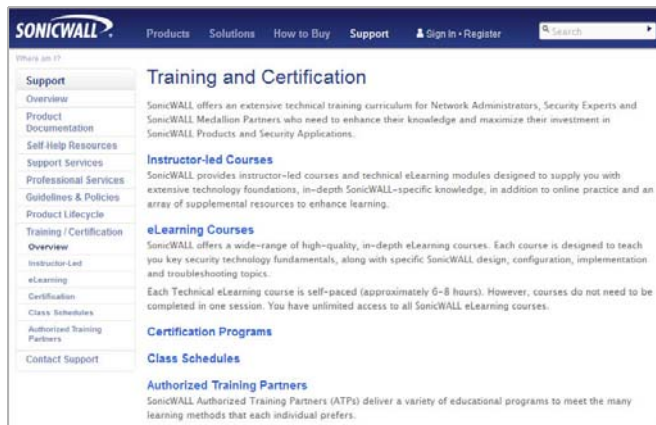

The screenshot shows the SonicWALL website's "Training and Certification" page. The page has a dark blue header with the SonicWALL logo and navigation links for Products, Solutions, How to Buy, Support, Sign In, and Register. A search bar is located in the top right corner. On the left side, there is a vertical navigation menu with the following items: Support (highlighted), Overview, Product Documentation, Self Help Resources, Support Services, Professional Services, Guidelines & Policies, Product Lifecycle, Training / Certification, Overview, Instructor-Led, eLearning, Certification, Authorized Training Partners, and Contact Support. The main content area is titled "Training and Certification" and contains the following text: "SonicWALL offers an extensive technical training curriculum for Network Administrators, Security Experts and SonicWALL Medallion Partners who need to enhance their knowledge and maximize their investment in SonicWALL Products and Security Applications." Below this, there are three sections: "Instructor-led Courses" (describing instructor-led courses and technical eLearning modules), "eLearning Courses" (describing a wide-range of high-quality, in-depth eLearning courses), and "Certification Programs" (with sub-sections for "Class Schedules" and "Authorized Training Partners").

Related Documentation

See the following documents for more information:

- *SonicWALL CDP Administrator's Guide*
- *SonicWALL CDP Agent User's Guide*
- *SonicWALL CDP MS Exchange InfoStore Backup and Restore Guide*
- *SonicWALL CDP MS Exchange User Mailbox Backup and Restore Guide*
- *SonicWALL CDP Local Archiving Guide*

For further information, visit:

<<http://www.sonicwall.com/us/support/289.html>>

The screenshot shows the SonicWALL support website interface. At the top, there is a navigation bar with links for Products, Solutions, How to Buy, Support, and a user login/register area. A search bar is also present. The left sidebar contains a 'Support' menu with sub-links: Overview, Product Documentation, Self-Help Resources, My Support Cases, Video Tutorials, Documentation, Downloads, User Forums, Knowledge Base, Support Services, Professional Services, Guidelines & Policies, Product Lifecycle, and Contact Support. The main content area is titled 'Support for SonicWALL® Products and Services'. It features a 'Service Bulletins' section with a recent entry about a vulnerability in E-Class SSL VPN ActiveX Control format. Below this is a 'Knowledge Base Search' section with a search input field and a 'Search...' button. A row of service icons includes Network Security, SSL VPN Secure Remote Access, Email Security, Backup & Recovery, Endpoint Security, and Management & Reporting. The 'Top Support Topics' section lists several articles, including 'Site-To-Site Local Seeding', 'Can CDP Backup Applications Beside Our Currently Supported Ones?', 'SONICWALL CDP 5.0.0.3 Release Notes', 'SonicWALL CDP 5.0 Application And Platform Support Matrix', 'How To Recover Your Password Or IP On A CDP 5-X Appliance', and 'The Exchange Application Failed To Start Because Esebd12.dll Was Not Found'. The 'Recent Video Tutorials' section features a video player for 'IP Address Recovery and User Password Reset' for the CDP Series, with a description: 'Recovering the IP Address and Restoring the User Password on a CDP'. Below the video are two smaller video thumbnails.

SonicWALL Secure Wireless Network Integrated Solutions Guide

The official guide to SonicWALL's market-leading wireless networking and security devices. This 512-page book is available in hardcopy. Order the book directly from Elsevier Publishing at: <<http://www.elsevier.com>>

Use SonicWALL wireless solutions to deploy secure wireless networks of any shape or size!

Do Wireless. Securely.
Nearly forty percent of the world's 1 billion+ Internet users are wireless. It's a truly staggering fact to think that the majority of these wireless implementations are fundamentally insecure, leaving users and private data at risk.

Many wireless network proprietors think that the convenience of wireless outweighs the possible risk of an insecure implementation, or that secure wireless is far too complicated to worry about deploying.

Throughout this book, the engineers and documentation authors at SonicWALL prove the opposite is true. Wireless networks can be made as secure as wired networks, and deploying this type of security can be far less complicated than you think. In this book, and through their massive product offering, SonicWALL gives you the secure wireless network expertise of all of the planning, design, implementation, and optimizing tools you need to do wireless. Securely.

SonicWALL's Three Phases for a Secure Wireless Network
Using a comprehensive approach to security, SonicWALL guides you through a complete integrated solution for a secure wireless network using a three phase approach.

Phase 1 UTM Gateway	Phase 2 Secure Remote Access	Phase 3 Centralized Management
-------------------------------	--	--

Syngress Solutions Memberships!
Your Solutions Membership gives you access to the downloadable e-book version at no additional charge.

- Full color PDF format version of the print book
- Print, copy, and comment features all enabled
- Updates to the print book if needed

www.syngress.com/solutions

SonicWALL Secure Wireless Network Integrated Solutions Guide

SonicWALL
Secure Wireless Network
Integrated Solutions Guide

SonicWALL
Secure Wireless Network
Integrated Solutions Guide

Official guide from SonicWALL.

- Written by SonicWALL engineers and documentation specialists
- Appropriate for all audiences, from the small proprietor to the enterprise IT specialist
- A complete reference to plan, design, implement, and optimize a secure wireless network with SonicWALL's extensive wireless product offerings

Joe Levy
Khai Tran
Patrick Lydon
Jeremy Pollock
Dave Parry
Susan Weigand
with Zhong Chen, John Gruender, Mike Messing, Lauren Pederson, Hung Ha

SYNGRESS®
The Definition of a
"Serious Security Library"

1581 978-1-59749-192-8
55995



SYNGRESS®



In this Section:

This section provides regulatory, trademark, and copyright information.

- [*Safety and Regulatory Information - page 38*](#)
- [*Mounting the SonicWALL CDP 6080 - page 39*](#)
- [*Mounting Instructions in German - page 40*](#)
- [*Lithium Battery Warning - page 42*](#)
- [*Cable Connections - page 42*](#)
- [*Adding the CDP 6080 Expansion Pack - page 43*](#)
- [*Replacing a Single Hard Drive - page 47*](#)
- [*FCC Part 15 Class A Notice - page 50*](#)
- [*Copyright Notice - page 52*](#)
- [*Trademarks - page 52*](#)

Safety and Regulatory Information

Regulatory Model/Type	Product Name
2RK02-067	SonicWALL CDP 6080 SonicWALL CDP 6080B

Unauthorized Ports

Do not plug devices into any ports (other than those indicated) unless explicitly instructed to do so by a SonicWALL technical support representative. Doing so may void your warranty.

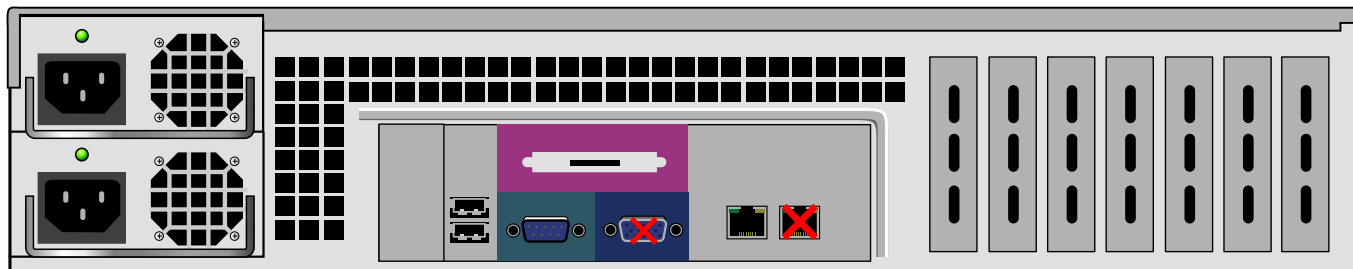

Mounting the SonicWALL CDP 6080

The SonicWALL CDP appliance is designed to be mounted in a standard 19-inch rack mount cabinet. The following conditions are required for proper installation:

- Use the mounting hardware recommended by the rack manufacturer and ensure that the rack is adequate for the application.
- Four mounting screws, compatible with the rack design, must be used and hand tightened to ensure secure installation. Choose a mounting location where all four mounting holes line up with those of the mounting bars of the 19-inch, rack mount cabinet.
- Mount in a location away from direct sunlight and sources of heat. An ambient temperature of 104° F (40° C) is the maximum allowed.
- Route cables away from power lines, fluorescent lighting fixtures, and sources of noise such as radios, transmitters, and broadband amplifiers.
- As shipped from the factory this SonicWALL product includes two power supplies for redundant AC power and added reliability. A field conversion is available to convert to DC mains.
- The included power cord is intended for use in North America AC mains installation only. For European Union (EU) customers, and DC mains, a power cord is not included.
- Ensure that no water or excessive moisture can enter the unit.

- Allow unrestricted airflow around the unit and through the vents on the side of the unit. A minimum of 1 inch (25.4mm) clearance is recommended.
- If installed in a closed or multi-unit rack assembly, the operating ambient temperature of the rack environment may be greater than room ambient. Therefore, consideration should be given to installing the equipment in an environment compatible with the maximum recommended ambient temperature shown above.
- Mount the SonicWALL appliances evenly in the rack in order to prevent a hazardous condition caused by uneven mechanical loading.
- Consideration must be given to the connection of the equipment to the supply circuit. The effect of overloading the circuits has minimal impact on overcurrent protection and supply wiring. Appropriate consideration of equipment nameplate ratings must be used when addressing this concern.
- DC configuration includes input cable with protective earthing conductor (green and yellow wire). This conductor must be connected to safety earth ground of circuit.
- Never remove or install a power supply while the power cord is attached to the power supply that is being removed or installed.
- A suitably rated and approved branch circuit breaker shall be provided as part of the building installation. Follow local code when purchasing materials or components.

- This model is shipped as AC mains configuration uses standard 3 conductor appliance couplers. A field conversion is available to change to DC mains. The DC mains is connected to terminal post. Do not connect AC configured product to DC mains and do not connect DC configured product to AC. Detailed instructions are provided with the DC conversion kit. Product must be configured as all DC or all AC.
- DC rating includes tolerances. Do not operate product outside of range shown on product label.
- This product is not intended to be installed and used in a home or public area accessible to the general population. When installed in schools this equipment must be installed in a secure location accessible only by trained personnel.
- Thumbscrews should be tightened with a tool after both installation and subsequent access to the rear of the product.
- Reliable grounding of rack-mounted equipment must be maintained. Particular attention must be given to power supply connections other than direct connections to the branch circuits, such as power strips.
- To disconnect AC power, both power cords must be removed.
- To disconnect DC power, an external properly rated disconnect device must be provided by building or rack installation.

Mounting Instructions in German

Das SonicWALL Modell ist für eine Montage in einem standardmäßigen 19-Zoll-Rack konzipiert. Für eine ordnungsgemäße Montage sollten die folgenden Hinweise beachtet werden:

- Vergewissern Sie sich, dass das Rack für dieses Gerät geeignet ist und verwenden Sie das vom Rack-Hersteller empfohlene Montagezubehör.
- Verwenden Sie für eine sichere Montage vier passende Befestigungsschrauben, und ziehen Sie diese mit der Hand an. Wählen Sie einen Ort im 19-Zoll-Rack, wo alle vier Befestigungen der Montageschienen verwendet werden.
- Wählen Sie für die Montage einen Ort, der keinem direkten Sonnenlicht ausgesetzt ist und sich nicht in der Nähe von Wärmequellen befindet. Die Umgebungstemperatur darf nicht mehr als 40 °C betragen.
- Achten Sie darauf, dass sich die Netzkabel nicht in der unmittelbaren Nähe von Stromleitungen, Leuchtstoffröhren und Störquellen wie Funksendern oder Breitbandverstärkern befinden.
- Das beigefügte Netzkabel ist nur für den Gebrauch in Nordamerikas vorgesehen. Für Kunden in der Europäischen Union und Gleichstromversorgung ist kein Netzkabel beigefügt.
- Stellen Sie sicher, dass das Gerät vor Wasser und hoher Luftfeuchtigkeit geschützt ist.

- Stellen Sie sicher, dass die Luft um das Gerät herum zirkulieren kann und die Lüftungsschlitze an der Seite des Gehäuses frei sind. Hier ist ein Belüftungsabstand von mindestens 26 mm einzuhalten.
- Wenn das Gerät in einem geschlossenen 19"-Gehäuse oder mit mehreren anderen Geräten eingesetzt ist, wird die Temperatur in der Gehäuse höher sein als die Umgebungstemperatur. Achten Sie darauf, daß die Umgebungstemperatur nicht mehr als 40° C beträgt.
- Bringen Sie die SonicWALL waagrecht im Rack an, um mögliche Gefahren durch ungleiche mechanische Belastung zu vermeiden.
- Prüfen Sie den Anschluss des Geräts an die Stromversorgung, damit der Überstromschutz sowie die elektrische Leitung nicht von einer eventuellen Überlastung der Stromversorgung beeinflusst werden. Prüfen Sie dabei sorgfältig die Angaben auf dem Aufkleber des Geräts.
- Wenn Sie das Netzteil wechseln, entfernen Sie unbedingt die Stromversorgung von dem zu wechselnden Netzteil.
- Ein angemessen dimensionierter und geprüfte Sicherung, sollte Bestandteil der Haus-Installation sein. Bitte folgen die den lokalen Richtlinien beim Einkauf von Material oder Komponenten.
- Dieses Produkt wird mit zwei Wechselstrom-Netzteilen als redundant Stromversorgung zur erhöhten Verfügbarkeit ausgeliefert. Ein Umbaukit in Gleichstromversorgung ist verfügbar.
- Die Wechselstrom Konfiguration verwendet standardisierte Kaltgerätekabel. Sie können einem Umbaukit für Gleichstrom bestellen. Die DC-Hauptleitungen wird an Terminalpfosten angeschlossen. Schließen Sie kein Wechselstrom konfiguriertes Produkt an Gleichstrom an. Und schließen Sie kein Gleichstrom konfiguriertes Produkt an Wechselstrom an. Das Umbaukit beinhaltet eine detaillierte Beschreibung. Das Gerät muss komplett mit Gleichstrom oder Wechselstrom konfiguriert sein.
- Gleichstrom akzeptiert Toleranzen. Betreiben Sie das Gerät nicht außerhalb des Bereiches, der auf dem Aufkleber des Gerätes angegeben ist.
- Die Gleichstrom Konfiguration beinhaltet einen Anschlusskabel mit Erdung (Grün-Gelbes Kabel). Diese Kabel muss an den Erdungsschaltkreis angeschlossen werden.
- Dieses Produkt ist nicht dafür entwickelt, um in Bereichen mit öffentlichem Zugriff betrieben zu werden. Wenn es in Schulen betrieben wird stellen Sie sicher, dass sich das Gerät in einem abgeschlossenen Raum installier wird, der nur von speziell ausgebildetem Personal betrieben werden kann.
- Vergewissern Sie sich, dass die Schrauben nach dem Austausch mit entsprechendem Werkzeug fest angezogen werden.
- Eine sichere Erdung der Geräte im Rack muss gewährleistet sein. Insbesondere muss auf nicht direkte Anschlüsse an Stromquellen geachtet werden wie z. B. bei Verwendung von Mehrfachsteckdosen.

Lithium Battery Warning

The Lithium Battery used in the SonicWALL Internet security appliance may not be replaced by the user. The SonicWALL must be returned to a SonicWALL authorized service center for replacement with the same or equivalent type recommended by the manufacturer. If, for any reason, the battery or SonicWALL Internet security appliance must be disposed of, do so following the battery manufacturer's instructions.

Cable Connections

All Ethernet cables are designed for intra-building connection to other equipment. Do not connect these ports directly to communication wiring or other wiring that exits the building where the SonicWALL is located.

Hinweis zur Lithiumbatterie

Die in der Internet Security appliance von SonicWALL verwendete Lithiumbatterie darf nicht vom Benutzer ausgetauscht werden. Zum Austauschen der Batterie muss die SonicWALL in ein von SonicWALL autorisiertes Service-Center gebracht werden. Dort wird die Batterie durch denselben oder entsprechenden, vom Hersteller empfohlenen Batterietyp ersetzt. Beachten Sie bei einer Entsorgung der Batterie oder der SonicWALL Internet Security appliance die diesbezüglichen Anweisungen des Herstellers.

Kabelverbindungen

Alle Ethernet-Kabel eignen sich für die Verbindung von Geräten in Innenräumen. Schließen Sie an die Anschlüsse der SonicWALL keine Kabel an, die aus dem Gebäude herausgeführt werden, in dem sich das Gerät befindet.

Adding the CDP 6080 Expansion Pack

The SonicWALL CDP 6080 Expansion Pack contains four hard drives to insert into the secondary array slots of your SonicWALL CDP appliance. You can insert the drives into your CDP appliance while it is powered on.

To add and activate the Expansion Pack, you will need access to MySonicWALL and to the SonicWALL CDP Web management interface. Your CDP appliance must have Internet access to connect to the SonicWALL licensing server to activate the new drives.

The Expansion Pack license key is provided on the certificate included in the Expansion Pack shipping box. The license key must be entered in your MySonicWALL account before you can access the drives.

The front bezel on the SonicWALL CDP appliance covers the drive slots. The bezel can be unlocked with the front bezel security key supplied with the appliance.

See the following sections:

- [Adding the Expansion Pack License Key to MySonicWALL - page 43](#)
- [Activating the Expansion Pack License on the SonicWALL CDP Appliance - page 44](#)
- [Inserting the Expansion Pack Drives - page 45](#)

Adding the Expansion Pack License Key to MySonicWALL

To add the Expansion Pack license key to your SonicWALL CDP appliance on MySonicWALL, perform the following steps:

1. Open a Web browser on the computer you are using to manage the SonicWALL CDP 6080.
2. Enter <http://www.mysonicwall.com> in the **location** or **address** field.
3. On the **MySonicWALL login** page, enter your MySonicWALL account username and password in the appropriate fields and then click the **Submit** button.
4. In the **Register A Product** field, enter the license key for the Expansion Pack, and then click **Next**.
5. If you have more than one registered SonicWALL CDP 6080 appliance, select the one on which you plan to install the Expansion Pack. The **Service Management** page displays.



Note: *The Expansion Pack license key can only be applied to one SonicWALL CDP 6080 appliance.*

6. On the **Service Management** page, you can scroll down to verify that the **Expansion Pack** row under **Desktop & Server Software** does *not* show **Enter Key** in the **Options** column, since you have already entered the license key.

- Optionally click the **Expansion Pack** link to view the status.

Status - Expansion Pack

Your Expansion Pack Service has been activated.

Serial Number:	0017C5663D24
Activation Status:	Enabled
Node Support:	1
Number Of Licenses:	1

Activating the Expansion Pack License on the SonicWALL CDP Appliance

After adding the Expansion Pack license key to the SonicWALL CDP appliance on MySonicWALL, you must activate the license on the appliance itself in the Web management interface.

To activate the Expansion Pack license on the SonicWALL CDP appliance, perform the following steps:

- Log into the Web management interface and navigate to the **System > Registration/Licenses** page.
- Click the **Refresh** button to force the appliance to communicate with the SonicWALL licensing server and apply the Expansion Pack license.

The **Security Services** table is updated to show that the Expansion Pack is licensed.

System > Registration/Licenses

Registration Licenses Manual Keyset

Security Service	Status	Count	Expiration
Bare Metal Recovery - Workstation	Licensed	10	
Bare Metal Recovery - Server	Licensed	4	
Box to Box Backup	Not Licensed		
Server Licenses	Licensed	15	
Workstation Licenses	Licensed	100	
Offsite Data Backup Service	Licensed	10 Gb	16 Sep 2011
Expansion Pack	Licensed	1	

Inserting the Expansion Pack Drives



Warning: *Do not insert anything other than the SonicWALL approved hard drives into the SonicWALL CDP appliance.*

The Web management interface provides a graphical view of the hard drive arrays on the SonicWALL CDP 6080 appliance. The best practice is to view the arrays on the **System > RAID** page during the insertion process.

To physically access the hard drive arrays, you must remove the front bezel. If the front bezel is locked, use the front bezel security key supplied with your appliance to unlock it.

To view the hard drive arrays and insert the Expansion Pack drives into the SonicWALL CDP appliance, perform the following steps:

1. In the Web management interface, navigate to the **System > RAID** page. The Secondary Array appears as black rectangles above the Main Array, indicating that no drives are present.

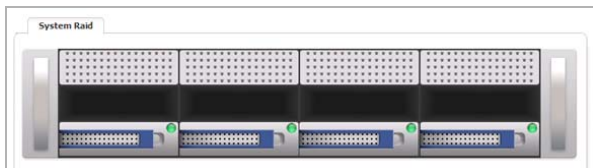

2. On your SonicWALL CDP appliance, use the front bezel key to unlock the front bezel, then remove the front bezel to expose the hard drive arrays.
3. Press the square buttons to pop out the handles and then remove the place holder inserts from slots D4, D5, D6, and D7 of the top array. The inserts prevent dust and foreign objects from getting into the drive slots.



Warning: *Be careful not to remove the hard drives from the **Main Array** (slots D0, D1, D2, and D3) while the appliance is powered on. Removing more than one drive from an active array will cause loss of data.*

4. Remove the hard drives from the Expansion Pack shipping carton.
5. Apply the stickers for D4, D5, D6, and D7 to the drive handles. While holding the drive with the label side up, place the sticker near the edge of the handle next to the square button.
6. Pop open the drive handle on the D4 hard drive by pressing the square button and insert the drive into slot **D4** (the left-most slot) of the Secondary Array, label side up with the handle sticking out.
7. Press the drive firmly into place to seat the connectors and then close the handle.
8. Pop open the handles on the D5, D6, and D7 drives and insert them into slots **D5**, **D6**, and **D7**, respectively. Press firmly to seat the connectors, and then close the handles.

9. As the **System > RAID** screen refreshes (every 30 seconds), you will see the LED indicators for the drive slots in the Secondary Array turn green as the SonicWALL CDP appliance senses the inserted drives. When all the drives are inserted, all drive slot LEDs turn green, and the **Add Expansion Pack** button appears.

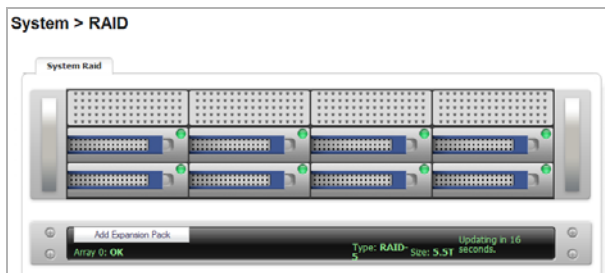

 **Note:** *If the Expansion Pack license has not been added to the SonicWALL CDP on both MySonicWALL and in the Web management interface, the **Add Expansion Pack** button is not displayed. You must activate the license before you can access the drives.*

10. Click the **Add Expansion Pack** button. The SonicWALL CDP appliance begins building the array. This can take up to 30 minutes.

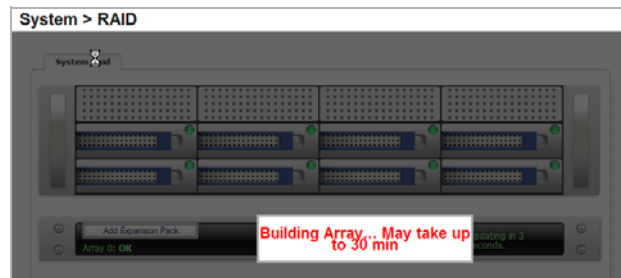

11. Wait until the SonicWALL CDP finishes building the array. When finished, the status displays **OK**.

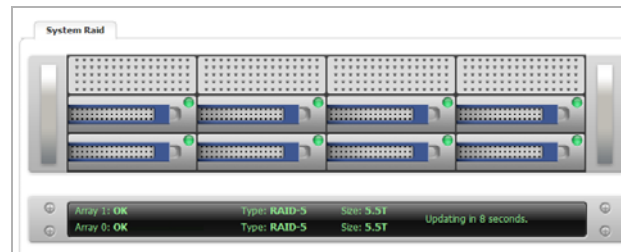

12. Re-install the front bezel, being sure to properly line up the LCD connectors.
The best practice is to align and seat the right side of the bezel (as you are facing the front of the SonicWALL CDP appliance), then view the connectors from above as you carefully press the left side of the bezel into place.
13. Lock the bezel with the front bezel security key.

Replacing a Single Hard Drive

The 2 TB replacement hard drive can be inserted into any drive slot on your SonicWALL CDP 6080 appliance. You can insert the drive while the SonicWALL CDP appliance is powered on.

The front bezel on the SonicWALL CDP appliance covers the drive slots. The bezel can be unlocked with the front bezel security key supplied with the appliance.

The Web management interface provides a graphical view of the hard drive array on the SonicWALL CDP appliance. The best practice is to view the array on the **System > RAID** page during the replacement process.

Removing the Defective Hard Drive from the SonicWALL CDP Appliance

To view the hard drive arrays and remove the defective drive from the SonicWALL CDP appliance, perform the following steps:

1. On your SonicWALL CDP appliance, use the front bezel key to unlock the front bezel, then remove the front bezel to expose the hard drive array.
2. In the Web management interface, navigate to the **System > RAID** page.

The defective drive is indicated by a red LED. When you mouse over the drive, a drive status box displaying a status such as **DEVICE ERROR**, **UNKNOWN**, or **NOT-PRESENT** appears.

You might see a different status than those listed, depending on the condition of the drive as interpreted by the RAID controller.

A status of **DEGRADED** is displayed for the array.

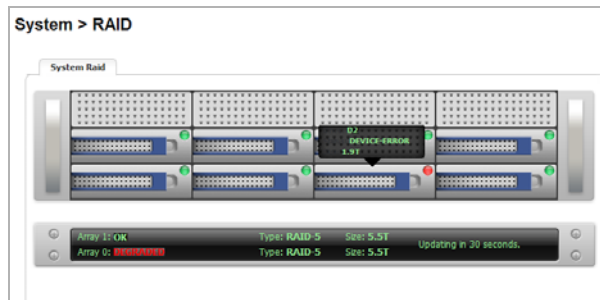

3. On the appliance, press the square button on the right side of the defective drive to pop out the drive handle.



Warning: *Be careful to remove only the defective drive from the drive array while the appliance is powered on. Removing more than one drive from an active array will cause loss of data.*

4. Grasp the drive handle and pull the drive straight out to remove it from the slot.

On the **System > RAID** page, the removed drive is indicated by an empty, black slot in the drive array. A status of **DEGRADED** is still displayed for the array.

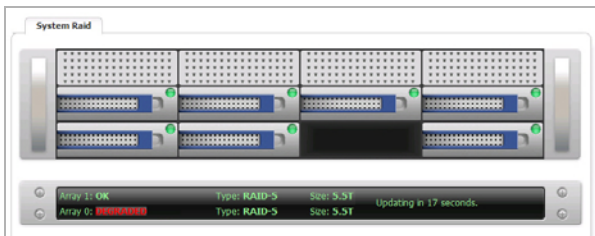

Inserting the Replacement Drive into the SonicWALL CDP Appliance



Warning: *Do not insert anything other than the SonicWALL approved hard drive into the SonicWALL CDP appliance.*

To view the hard drive array and insert the replacement drive into the SonicWALL CDP appliance, perform the following steps:

1. Remove the hard drive and the drive number stickers from the replacement drive shipping carton.
2. Depending on which drive you are replacing, apply the appropriate sticker to the drive handle. While holding the drive with the label side up, place the sticker near the edge of the handle next to the square button.
3. In the Web management interface, navigate to the **System > RAID** page.

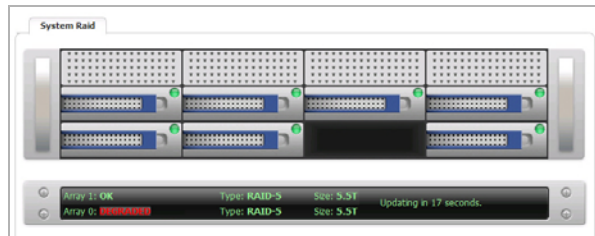

- Pop open the drive handle on the new hard drive by pressing the square button.
- Insert the drive into the empty slot, label side up with the handle sticking out.
- Press the drive firmly into place to seat the connectors, and then close the handle.
- As the **System > RAID** screen refreshes (every 30 seconds), you will see the status change to **REBUILD-PAUSED**.

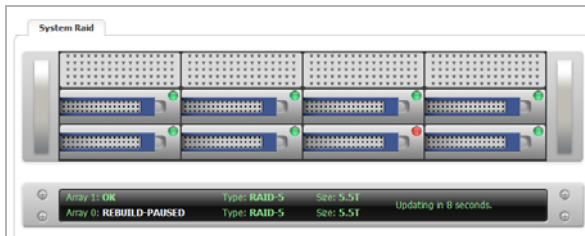

The status changes to **REBUILDING** within a few minutes.

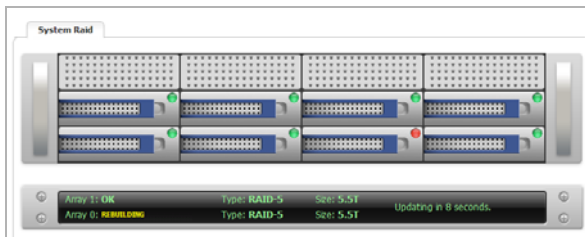

- You may continue to use your SonicWALL CDP appliance while the RAID controller rebuilds the array with the new drive. The rebuilding process requires at least six hours and could take several times longer, depending on the amount of data contained in the array.



Warning: *There is a noticeable performance degradation of the RAID array while it is being rebuilt.*

When finished rebuilding, the drive LED changes to green and the status for the array changes to **OK**.

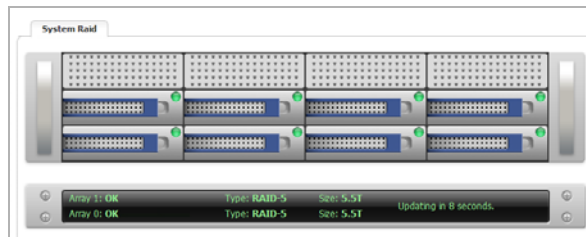

- Re-install the front bezel, being sure to properly line up the LCD connectors. The best practice is to align and seat the right side of the bezel (as you are facing the front of the SonicWALL CDP appliance), then view the connectors from above as you carefully press the left side of the bezel into place.
- Lock the bezel with the front bezel security key.

FCC Part 15 Class A Notice

This equipment was tested and found to comply with the limits for a Class A digital device, pursuant to Part 15 of the FCC Rules. These limits are designed to provide reasonable protection against harmful interference when the equipment is operated in a commercial environment. This equipment generates, uses, and can radiate radio frequency energy. And if not installed and used in accordance with the instruction manual, the device may cause harmful interference to radio communications. Operation of this equipment in a residential area is likely to cause harmful interference in which case the user is required to correct the interference at his own expense.

Notice About Modifying Equipment

Caution: *Modifying this equipment or using this equipment for purposes not shown in this manual without the written consent of SonicWALL, Inc. could void the user's authority to operate this equipment.*

Canadian Radio Frequency Emissions Statement

This Class A digital apparatus complies with Canadian ICES-003.

Cet appareil numérique de la classe A est conforme à la norme NMB-003 du Canada.

BMSI Statement

警告使用者：
這是甲類的資訊產品，在居住的環境中使用時，可能會造成射頻干擾，在這種情況下，使用者會被要求採取某些適當的對策。

VCCI Statement

この装置は、クラスA情報技術装置です。この装置を家庭環境で使用すると電波妨害を引き起こすことがあります。この場合には使用者が適切な対策を講ずるよう要求されることがあります。

VCCI-A

添付の電源コードに関して: 電気安全を確保するために、弊社製品にご使用いただく電源コードは必ず製品同梱の電源コードをご使用ください。この電源コードは他の製品では使用できません。

CISPR 22 (EN 55022) Class A

Complies with EN 55022 Class A and CISPR 22 Class A. This is a class A product. In a domestic environment, this product may cause radio interference, in which case the user may be required to take adequate measures.

Declaration of Conformity

Application of Council Directive	2004/108/EC (EMC) and 2006/95/EC (LVD)
Standards to which conformity is declared	EN 55022 (2006) +A1 (2007) Class A EN 55024 (1998) +A1 (2001), +A2 (2003) EN 61000-3-2 (2006) EN 61000-3-3 (2008) EN 60950-1 (2006) +A11
	National Deviations: AR, AT, AU, BE, CA, CH, CN, CZ, DE, DK, FI, FR, GB, GR, HU, IL, IN, IT, JP, KE, KR, MY, NL, NO, PL, SE, SG, SI, SK, US

Regulatory Information for Korea



Certificate Number SWL-2RK02-067

All products with country code "" (blank) and "A" are made in the USA. All products with country code "B" are made in China.

All products with country code "C" or "D" are made in Taiwan R.O.C.

A급 기기 (업무용 정보통신기기)

이 기기는 업무용으로 전자파적합등록을 한 기기이오니 판매자 또는 사용자는 이 점을 주의하시기 바라며, 만약 잘못판매 또는 구입하였을 때에는 가정용으로 교환하시기 바랍니다.

Copyright Notice

© 2012 SonicWALL, Inc.

All rights reserved.

Under the copyright laws, this manual or the software described within, can not be copied, in whole or part, without the written consent of the manufacturer, except in the normal use of the software to make a backup copy. The same proprietary and copyright notices must be affixed to any permitted copies as were affixed to the original. This exception does not allow copies to be made for others, whether or not sold, but all of the material purchased (with all backup copies) can be sold, given, or loaned to another person. Under the law, copying includes translating into another language or format.

Specifications and descriptions subject to change without notice.

Trademarks

SonicWALL is a registered trademark of SonicWALL, Inc.

Microsoft Windows 7, Windows Vista, Windows XP, Windows Server 2003, Windows Server 2008, Internet Explorer, and Active Directory are trademarks or registered trademarks of Microsoft Corporation.

Other product and company names mentioned herein may be trademarks and/or registered trademarks of their respective companies and are the sole property of their respective manufacturers.

SonicWALL, Inc.

2001 Logic Drive
San Jose CA 95124-3452

T +1 408.745.9600
F +1 408.745.9300

www.sonicwall.com

P/N 232-002104-50
Rev A 2/2012



DYNAMIC SECURITY FOR THE GLOBAL NETWORK™

©2012 SonicWALL, Inc. is a registered trademark of SonicWALL, Inc. Other product names mentioned herein may be trademarks and/or registered trademarks of their respective companies. Specifications and descriptions subject to change without notice.